

DECACLIMA

Innovation in air treatment units

GENERAL CATALOGUE



DECACLIMA

Reliable and efficient **air-conditioning solutions** for very demanding sectors, such as hospital, pharmaceutical, food and other industrial areas and service sector applications



Request a
no-obligation **quote**



Our technical team will advise you to find the solution best suited to your needs.

DECACLIMA is specialised in air-conditioning equipment and solutions, offering optimised air treatment units with smart controls for projects that need custom solutions with high technical requirements.

It stands out for its customer orientation, providing value, innovation and efficiency in every design and unit it develops.

The quality procedures used by DECACLIMA are certified by BUREAU VERITAS according to ISO 9001.

CERTIFIED
ISO 9001



Specialised in air-conditioning equipment

Air treatment units for large flow rates



Direct expansion air treatment units



Compact air treatment units



Dehumidifiers



Air treatment units for the naval sector



Bio-air conditioners



Heat recovery units



Air purifiers



DECACLIMA makes reliable and efficient air-conditioning systems, designed to meet the needs of **highly demanding sectors**

Pharmaceutical



Industry



Commercial



Hospitals

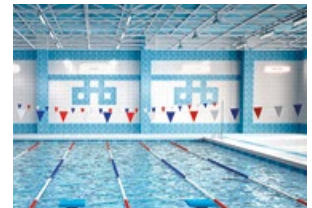

Sport



Horeca



Education



Culture



Naval

DECACLIMA

Our commitment to **global sustainability, excellence and innovation** helps us manage our future at the service of our clients



Innovation

In a constantly evolving world, our dedication to innovation makes us one of the leaders in the air-conditioning sector, offering comprehensive solutions.

At DECACLIMA, the constant technological evolution allows us to offer solutions that not only meet current, but also anticipate future needs.

Construction

We use the best construction systems to ensure optimum performance and an exceptional finish on our units.

Sustainability

DECACLIMA's commitment to sustainability is reflected in the design of efficient products, and our adherence to a strategy that focuses on reducing our carbon footprint, waste and environmental impacts.

Excellence

At DECACLIMA, excellence is based on exceeding our clients' expectations by offering custom products and services that meet all of their needs. Each unit is designed to offer the most efficient and advanced solutions.



Service

We adapt our customer service to the needs of each project, providing comprehensive advice from the initial design phase to the implementation of the installation.

Engineering

We are specialised in designing and manufacturing solutions and tailor made equipment. Our products integrate the most innovative and efficient solutions to ensure the best results.

Product certifications



All our units from the GC range have undergone rigorous checks and have the **Eurovent certification**

DECACLIMA has certifications that are recognised worldwide within its sector, so clients can be assured of the performance of its units through evaluations carried out by independent laboratories.

The GC range units have been assessed extensively, obtaining the **Eurovent certification**, which is recognised and respected worldwide by the sector.

This certification provides a guarantee for clients that the products meet the highest standards of performance and efficiency, endorsed by a transparent and reliable certification process. The Eurovent certification reflects DECACLIMA's ongoing commitment to customer satisfaction, providing reliable and efficient solutions for air conditioning and air treatment needs.

The performance of DECACLIMA's GC units is guaranteed by the **Eurovent certification**



GC range features	DIN EN 1886:2009 class
Mechanical resistance	D1 (M)
Filter bypass	F9 (M)
Thermal transmittance	T2
Thermal bridge	TB2

Other certifications

DECACLIMA also has tests carried out by the TÜV NORD independent laboratory, with results that certify a high mechanical performance with **T2 thermal transmittance** and **TB2 thermal bridge**.

This ensures good thermal insulation of the casing, maximum mechanical resistance and minimum air leakage, offering optimal units to its clients for all applications.

According
EN 1886:2009



Tested by:
TÜV NORD
Systems GmbH
& Co. KG

ErP 2018

All Decaclima units meet **Directive ErP2018**, ensuring that European Union environmental requirements are met from the design phase and highly-efficient and environmentally friendly units are manufactured.



DECACLIMA

At DECACLIMA, we are committed to providing **maximum comfort and efficiency**



Plug&Play units

Innovation, efficiency and service

Units designed with the PLUG&PLAY principle, simplifying the connection and featuring all control systems necessary for any application. These units also use communication protocols such as ModBus, BACnet, KNX, etc.

The smart management of multiple parameters contributes to energy efficiency, reducing operating costs and minimising the environmental impact

Plug&Play units

Built-in control

DECACLIMA's **smart air-conditioning systems** ensure complete control of the environment, providing an area of comfort for occupants

DECACLIMA's air conditioners are designed to features an optimised control for each application. These control systems with advanced technology allow humidity, temperatures and pressures to be adjusted precisely to ensure the optimum environment.



Web server option

Built-in web server to access all detailed information for the air conditioners and monitor and adjust the settings from anywhere via a user-friendly interface.

BMS connectivity. *Building Management System*

Building management system to integrate air-conditioning solutions and obtain centralised monitoring, optimising efficiency and responding to the needs of environmental conditions.



Multidimensional control

Free programming of temperature, humidity and pressure parameters, giving you full control over the microclimate of spaces in order to meet the specific needs of users and processes.

Remote control

Option of controlling air conditioners when you are outside the installation from anywhere. With remote control, it is possible to manage and adapt the environment of each area according to your needs.

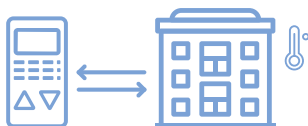

Plug&Play units

Unit or project monitor



Complete project integration

Unified information from the design to the implementation of your project.

A step forwards in managing air treatment units



Dynamic animations

Visual understanding of the unit's key performance parameters.



Advanced project visualisation allows **units to be controlled and monitored** visually and intuitively

Benefits of Advanced Visualisation

Operating efficiency: Control the performance of each air treatment unit easily and adjust settings in real time from a central location.

Predictive maintenance: anticipate possible issues so as to prevent them with alarms and detailed visualisations.

Easy to manage: control and monitor all units from a central location, facilitating decision-taking.



Real-time alarms

Instantaneous visual notifications in the event of any anomaly.



Status visualisations

Detailed status visualisations for one or several units.



Emergency contact

The units can be stopped via an external signal in case of emergency or fire.

How to integrate **Advanced Visualisation** in your project

To make the most of this tool, DEACCLIMA's team of experts is on hand to guide you through the process of integrating advanced project visualisation.

DECACLIMA

DECACLIMA manufactures units with water-tight doors with hinged or pressurised perimeter locks, adapting to **specific applications** that require these features

Construction aspects

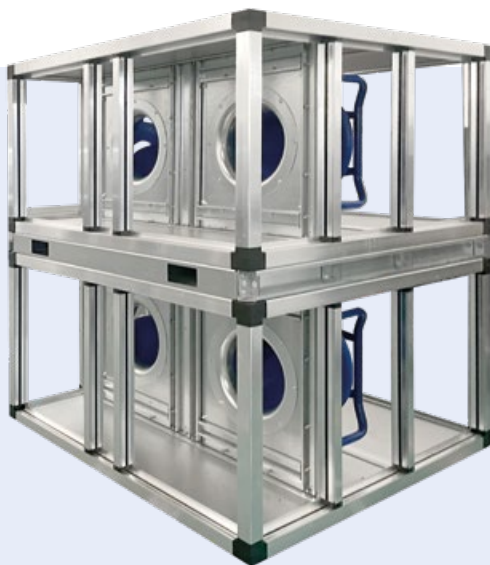
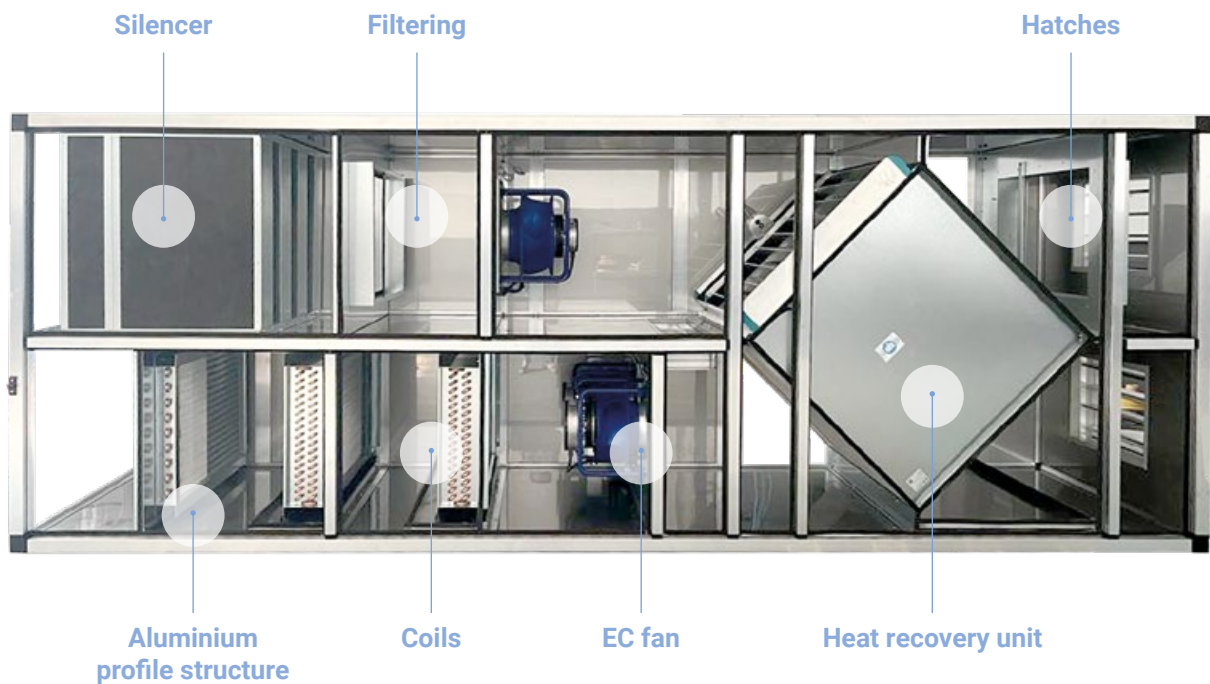

Structure

Air treatment units are generally constructed using aluminium profiles with sanitation baseboard.

To ensure the water-tightness of the panel joint, a closed-cell neoprene seal is added to the unit's profile. The joint between profiles uses pressure cast angled nylon joints.

Optionally, the treatment for corrosive environments, with interior and exterior stainless steel finishes can be requested.

DECACLIMA

Construction aspects

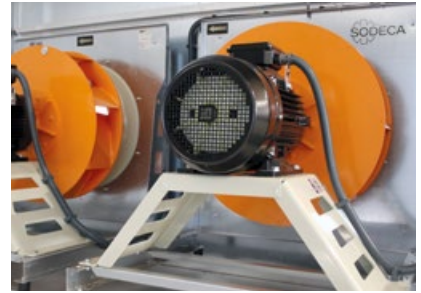
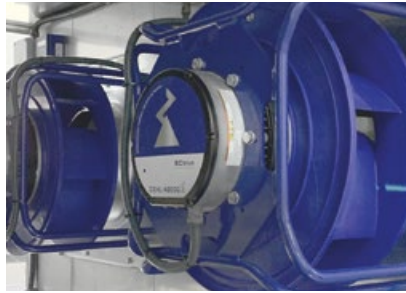

EC fans

High efficiency EC fans to ensure a constant flow rate in the installations.

EC, AC and ATEX fans

Extremely robust fans for very demanding applications.



Modules

Flexibility of installing modules to adjust the size according to needs. Connectors between modules and electrical connections for easy and safe integration.

Connectors between modules

Connectors between modules to facilitate assembly on site.

Heat recovery units

Heat recovery units with a bypass option to meet current regulations and improve the unit's performance. Cross-flow, counterflow, rotary and heat recovery units with coils are available.



Filters

Different filtration stages meeting the UNE-EN ISO 16890:2017 standard.

Silencers

Silencers for critical environments, with a wide range of flow rates and variety of attenuation settings.

Support brackets and frames

UPN profiles to establish a self-supporting base.



Electrical control panels

Panels with a high degree of protection for the power and control elements.



Coils

Direct expansion, water, electrical and steam coils. Custom options to control the area's temperature and humidity.

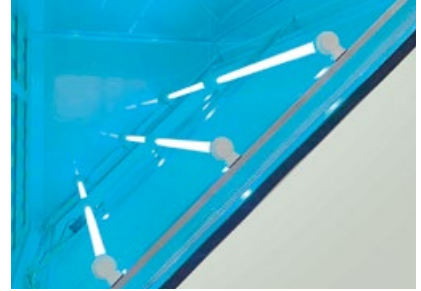

UVC modules

Germicidal chamber with ultraviolet lamps integrated in the units to inactivate viruses and bacteria and ensure a clean and safe space.



Inspection doors

Folding inspection doors with safety locks that ensure water-tightness and easy maintenance.



Hatches

Aerodynamic slats made of aluminium and sealed with an airtight seal.



Outdoor installations

Lacquered stainless steel cowls for outdoor installations.

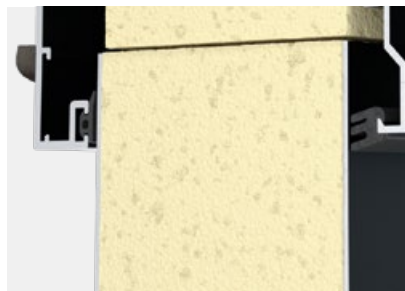

Lacquered sandwich panel

25 to 50 mm thick sound-absorbing panels with a galvanised or stainless steel finish, meeting the fire reaction classification according to standard UNE-EN 13501-1:2019.



Humidifiers

For environments where humidity must be controlled with resistance humidifiers, with a cellulose panel or electrodes.

Table of contents

01

Air treatment units for large flow rates

Large air conditioners



GC series

02

Direct expansion air treatment units

Air conditioners for large surfaces



GC series
ROOF TOP VRF

03

Compact air treatment units

Small air conditioners

Horizontal low-profile air conditioners



GC BS B series

Vertical low-profile air conditioners



GC BS V series

Vertical UP-FLOW air conditioners



GC BS U series

04

Air treatment units with low noise levels

Small air conditioners with low noise levels



GC BNS series

05

Dehumidifiers

Horizontal dehumidifier units



GC DH series

06

Air treatment units for the naval sector

Specially designed for high corrosion environments



GC NLV V series

GC NLV H series

07

Bio-air conditioners

Air treatment units for high energy efficiency applications



GC BIO V series

GC BIO H series

08

Heat recovery units

High-efficiency heat recovery units

Units with high-efficiency rotary heat exchanger



GC RER H series/GC RER V series

09

Air purifiers

With different filtration stages

Air purification units

Germicidal modules for ducts



PA series

Air treatment units for large flow rates

Large air conditioners

Air conditioners for industrial and commercial applications

GC series



GC series

Air treatment air conditioners for large flow rates GC series

Air conditioners for large flow rates and high energy efficiency, suitable for all types of air-conditioning installations in industrial processes. Designed to meet the most demanding requirements in terms of low energy consumption and high efficiency performance. The construction flexibility through modules allows the unit to be optimised in order to adapt it to any HVAC project need, thus simplifying its installation.



The quality of DECACLIMA's GC units is guaranteed by the **Eurovent certification**



Main characteristics

- Flow rates from 1,000 m³/h to 80,000 m³/h
- EC Plug Fan fans
- Hygienic construction in accordance with EN 13053
- High-quality components
- Wide variety of functions and options
- Extruded aluminium profile with thermal bridge break
- Rubber seal for air-tightness with the panels
- 50 mm thick sandwich-type panels, with a lacquered outer panel
- High-quality doors with locks for inspection and cleaning
- Support frames adapted to the needs of the installation

Standard finishes

- Galvanised steel interior
- Lacquered sheet exterior
- Modular aluminium structure

Options

- Lacquered or stainless steel interior finish
- Acoustic panels
- Rock wool panel
- Option of installing inspection windows and interior light
- Plug&Play built-in control
- AISI 304 stainless steel condensate tray
- Option of dividing the coil into modules
- Option of heat recovery coils

This series provides flexible solutions that can be adapted to the needs of the project and configured with heat recovery units (rotary, static, run-around), filtration stages with the efficiency required by the project or humidification systems (cellular panel, steam, atomisation). They can be equipped with communication protocols for an integrated control system such as ModBus, BACnet, KNX, LonWorks and others.

Technical characteristics

Model	Nominal flow rate m ³ /h	Model	Nominal flow rate m ³ /h	Model	Nominal flow rate m ³ /h
GC 1.5	1500	GC 10.5	10500	GC 30.0	30000
GC 3.0	3000	GC 12.0	12000	GC 35.0	35000
GC 4.5	4500	GC 15.0	15000	GC 40.0	40000
GC 6.0	6000	GC 18.0	18000	GC 50.0	50000
GC 7.5	7500	GC 21.5	21500	GC 60.0	60000
GC 9.0	9000	GC 24.0	24000	GC 80.0	80000

Dimensions mm

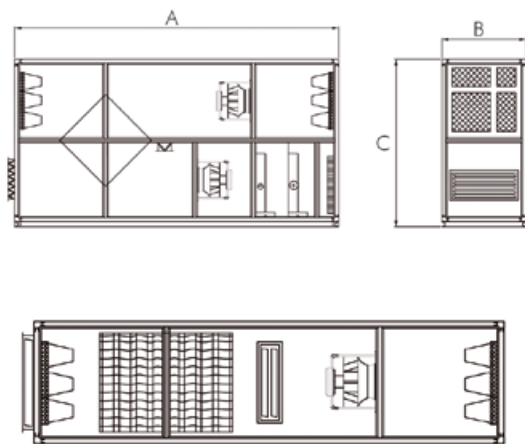

Model	Width (B) mm	Height (C) mm	Model	Width (B) mm	Height (C) mm
GC 1.5	1000	1200	GC 18.0	2200	3200
GC 3.0	1000	1800	GC 21.5	2500	3500
GC 4.5	1300	1800	GC 24.0	2500	3500
GC 6.0	1600	1800	GC 30.0	2500	4200
GC 7.5	1650	2100	GC 35.0	2500	4800
GC 9.0	1600	2600	GC 40.0	2800	4800
GC 10.5	1900	2400	GC 50.0	3400	4800
GC 12.0	1900	2700	GC 60.0	3400	5400
GC 15.0	2200	2900	GC 80.0	4400	5400

Data subject to modifications due to adjustments to the designs without prior notice.

Quick select

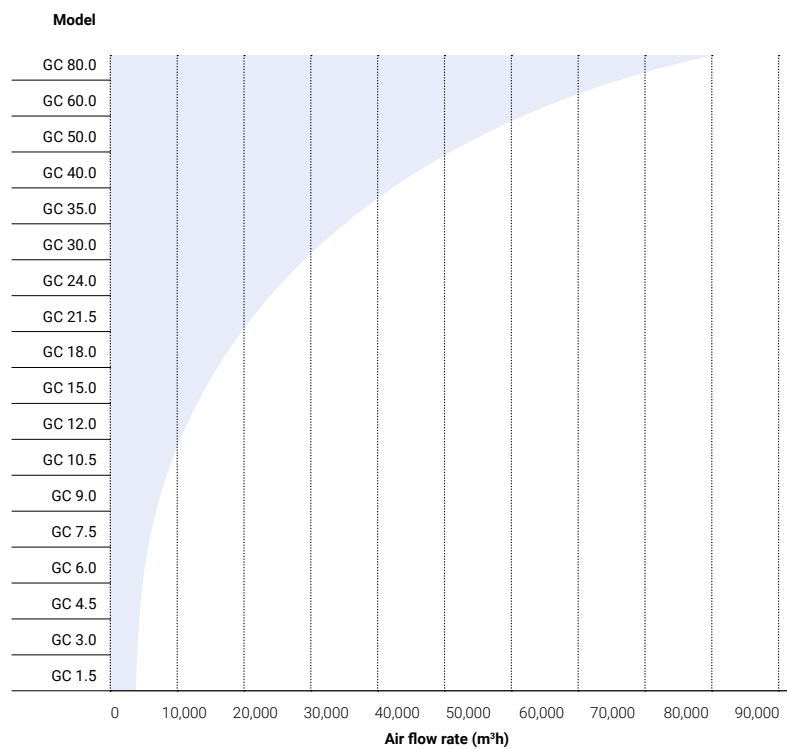

Direct expansion air treatment units

Air conditioners for large surfaces

Air conditioners with air recirculation,
100% outside air

GC ROOF TOP VRF
series



GC ROOF TOP VRF series

Direct expansion air conditioners, with the advantages of VRF

GC ROOF TOP VRF series

Compact design for installation on the roof or at ground level. Both the outdoor and indoor units come connected, saving the work of connecting pipes.



The quality of DECACLIMA's GC units is guaranteed by the **Eurovent certification**



Main characteristics

- Compatible with any VRF system
- High efficiency units
- Flow rates from 3,800 m³/h to 15,000 m³/h
- EC Plug Fan fans
- Extruded aluminium profile with thermal bridge break
- Rubber seal for water-tightness with the panels
- 50 mm thick sandwich-type panels, with a lacquered outer panel
- Support frame adapted to the needs of the installation
- Plug&Play built-in control

Standard finishes

- Galvanised steel interior
- Lacquered sheet exterior
- Modular aluminium structure with thermal bridge break

Options

- Hygienic construction
- Dehumidification stage
- Stainless steel interior finish
- UVc germicidal chamber
- Different filtration stages and characteristics
- Hatches module with heat recovery unit
- Communication for connection to a BMS
- Option of dividing the coil into modules
- Option of heat recovery coils

Operation

The GC ROOF TOP VRF series are high efficiency units thanks to their compatibility with any VRF system. The outdoor units selected offer high efficiency, adjusting to demand at all times.

Technical characteristics

Model		GC 1.5 RT 2.1 12 1 DX T	GC 3.0 RT 2.2 14 1 DX T	GC 3.0 RT 3.4 16 1 DX T	GC 4.5 RT 4.8 18 1 DX T	GC 4.5 RT 4.9 20 1 DX T	GC 4.5 RT 4.9 26 1 DX T
COOLING CAPACITY	kW	12.3	14	15.5	17.5	20	26
	Tr	3.5	4.0	4.4	5.0	5.7	7.4
HEATING CAPACITY	W	13.2	15.5	17	19	22	28.5
	Tr	3.8	4.4	4.8	5.4	6.3	8.1
FLOW RATE	m ³ /h	2050	2200	3400	4800	4850	4900
	cfm	1211	1300	2009	2836	2866	2895
COOLING CONSUMPTION	W	3413	4148	4746	5565	6405	7980
	A	5.5	6.7	7.6	8.9	10.3	12.8
EER	-	3.60	3.38	3.27	3.14	3.12	3.26
HEATING CONSUMPTION	W	3570	4260	5009	5775	6615	8190
	A	5.7	6.8	8	9.3	10.6	13.1
COP	-	3.70	3.64	3.39	3.29	3.33	3.48
NOISE LEVEL	dB(A)	57	57	57	59	59	60
STATIC PRESSURE	Pa	250	250	250	250	250	250
POWER SUPPLY	V	380-415 V 3 Phases + neutral 50 Hz	380-415 V 3 Phases + neutral 50 Hz	380-415 V 3 Phases + neutral 50 Hz	380-415 V 3 Phases + neutral 50 Hz	380-415 V 3 Phases + neutral 50 Hz	380-415 V 3 Phases + neutral 50 Hz
REFRIGERANT	-	R410A	R410A	R410A	R410A	R410A	R410A
LOAD	kg	3.9	4.5	4.9	5.2	5.8	7.2
CONTROL	Type	By return temperature	By return temperature	By return temperature	By return temperature	By return temperature	By return temperature
	Type	Constant flow rate	Constant flow rate	Constant flow rate	Constant flow rate	Constant flow rate	Constant flow rate
FAN	Type	EC Plug Fan	EC Plug Fan	EC Plug Fan	EC Plug Fan	EC Plug Fan	EC Plug Fan
COMPRESSORS	Type	DC Inverter	DC Inverter	DC Inverter	DC Inverter	DC Inverter	DC Inverter
OUTDOOR FLOW RATE	m ³ /h	6,000	6,000	6,000	6,800	11,000	11,000

Model		GC 6.0 RT 6.0 32 1 DX T	GC 7.5 RT 7.5 40 1 DX T	GC 7.5 RT 8.0 45 1 DX T	GC 9.0 RT 9.5 54 1 DX T	GC 12.0 RT 14.0 80 1 DX T	GC 15.0 RT 15.0 90 1 DX T
COOLING CAPACITY	kW	31	40	45	54	80	90
	Tr	8.87	11.4	12.8	15.4	22.8	25.6
HEATING CAPACITY	kW	34	45	50	57	90	100
	Tr	9.7	12.8	14.2	16.2	25.6	28.4
FLOW RATE	m ³ /h	6000	7500	8000	9500	14000	15500
	cfm	3545	4432	4727	5614	8273	9159
COOLING CONSUMPTION	W	9492	12257	14008	15960	24514	28016
	A	15.2	19.7	22.5	25.6	39.3	44.9
EER	-	3.27	3.26	3.21	3.38	3.26	3.21
HEATING CONSUMPTION	W	10017	12463	14111	16380	24926	28222
	A	16.1	20	22.6	26.3	40	45.3
COP	-	3.39	3.61	3.54	3.48	3.61	3.54
NOISE LEVEL	dB(A)	60	62	62	63	63	63
STATIC PRESSURE	Pa	400	400	400	400	400	400
POWER SUPPLY	V	380-415 V 3 Phases + neutral 50 Hz	380-415 V 3 Phases + neutral 50 Hz	380-415 V 3 Phases + neutral 50 Hz	380-415 V 3 Phases + neutral 50 Hz	380-415 V 3 Phases + neutral 50 Hz	380-415 V 3 Phases + neutral 50 Hz
REFRIGERANT	-	R410A	R410A	R410A	R410A	R410A	R410A
LOAD	kg	9.8	10.5	13.2	14.4	21	26.4
CONTROL	Type	By return temperature	By return temperature	By return temperature	By return temperature	By return temperature	By return temperature
	Type	Constant flow rate	Constant flow rate	Constant flow rate	Constant flow rate	Constant flow rate	Constant flow rate
FAN	Type	EC Plug Fan	EC Plug Fan	EC Plug Fan	EC Plug Fan	EC Plug Fan	EC Plug Fan
COMPRESSORS	Type	DC Inverter	DC Inverter	DC Inverter	DC Inverter	DC Inverter	DC Inverter
OUTDOOR FLOW RATE	m ³ /h	12000	16600	16600	22000	33200	33200

The nominal cooling capacities under conditions: Return 27 CBS/19 CBH, outdoor temperature 35 CBS. / The nominal heating capacities under conditions: Return 20°CBS, outdoor temperature 7°CBS/6°CBSH.
Range in indoor operating conditions: Cooling 17°CBS to 32°CBS heat 10 CBS to 28 CBS. / Range in outdoor operating conditions: Cooling 10°C to 45°C, heat -7°C to 24°C.

Data subject to modifications due to adjustments to the designs without prior notice.

Compact air treatment units

Small air conditioners

GC BS B

Horizontal low-profile air conditioners

GC BS V

Vertical low-profile air conditioners

GC BS U

Vertical UP-FLOW air conditioners

GC BS B

series

GC BS V

series

GC BS U

series



Compact air conditioners with small dimensions and hygienic construction

GC BS B series – GC BS V series – GC BS U series

This compact series of air conditioners is manufactured according to high-quality hygienic construction standards and with a built-in control compatible with any standard BMS protocol on the market. Ideal for air conditioning critical areas such as hospitals, clean rooms, laboratories or for health applications. The units can be connected to coolers, direct expansion or VRF units on the market.



Configurations

- GC BS B: Horizontal low profile units
- GC BS V: Vertical low profile units
- GC BS U: Bi-directional vertical UP-FLOW units

Versions

- For direct expansion and VRF
- For water

Main characteristics

- Hygienic construction in accordance with UNE/EN 13053, DIN 1946-4 and ASHRAE 170
- Double filtration stage
- Dirty filter pressure switch
- Plug Fan EC fans with flow regulator or constant pressure
- Extruded aluminium profile with thermal bridge break
- AISI 304 stainless steel condensates tray
- Double sided panels with a 25 mm interior thermal insulation
- Smooth interior
- Low noise level

Standard finishes

- Galvanised steel interior
- Lacquered sheet exterior
- Modular aluminium structure
- Sanitation baseboard

Options

- HEPA filtration module
- Humidifier module
- UVc germicidal chamber
- AISI 304 stainless steel interior
- Panel with 50 mm insulation
- Canopy for use outdoors
- Other configurations in accordance with the requirements
- Plug&Play control panel
- PLC that can be connected to different BMS protocols
- Option of dividing the coil into modules
- Option of heat recovery coils

Operation

For an easy installation and operation of all COMPACT series equipment, they may be equipped with specific controls that integrate the processes required by the air conditioning unit and establish communications with the building's BMS via any communications protocol.

Different versions of control exist for the most common applications, thus facilitating the integration of the project:

BASIC CONTROL

Designed for basic applications that do not require a strict control of the settings; ideal for use in comfort areas.

- ON / OFF
- Operating mode selection
- Temperature setting
- Constant flow ventilation
- Dirty filter indication
- 3-way valve outlet or integration in VRF units
- Communication for connection to a BMS



ENVIRONMENTAL CONTROL

Control based on an open programming PLC to control the temperature and humidity of the room to achieve thermal stability inside the room regardless of the condition of the exterior air that is entering the room.

Specifically designed for laboratories, operating rooms, data centres, document files, museums or locations that require very stable environmental conditions.

LABORATORY CONTROL

Fully programmable control with functions that can be adapted to the needs of the client's project and especially designed for rooms requiring a control that is configurable and adaptable to the process such as operating rooms, clean rooms, isolation rooms, etc.

- ON / OFF
- Operating mode selection
- Temperature setting
- Constant flow ventilation
- Outlet for extraction
- Outlet for exterior air mixture gates
- Speed settings
- Pressure and CO₂ probe inlet
- Dirty filters indication
- 3-way valve outlet or integration in VRF units
- Communication for connection to a BMS

- ON / OFF
- Operating mode selection
- Temperature setting
- Humidity setting
- Constant flow ventilation
- Outlet for extraction
- Outlet for exterior air mixture gates
- Air supply T/H limiting probe
- Flow rate adjustment
- Pressure and CO₂ probe inlet
- Dirty filters indication
- Modulating 3 way valves outlet with 2 and 4 ducts
- Modulating outlet to humidifier
- Communication for connection to a BMS

Low-profile air conditioners GC BS B series – GC BS V series

Low-profile air conditioners with a horizontal construction GC BS B or vertical construction GC BS V, to be installed in compact areas such as false ceilings. The adaptation of the manufacturing to the client's project allows manufacturing units tailored to each need.



Technical characteristics

Model		GC 1.5 BS B GC 1.5 BS V 1.07 19 DX/Ho	GC 1.5 BS B GC 1.5 BS V 1.5 9 19 DX/Ho	GC 3.0 BS B GC 3.0 BS V 3.0 20 19 DX/Ho	GC 4.5 BS B GC 4.5 BS V 4.0 28 19 DX/Ho
COOLING CAPACITY	kW	7.1	9	20	28
	TR	2	2.6	5.7	8
HEATING CAPACITY	kW	8.2	10.5	22	31
	KCAL	7052	9030	18920	26660
FLOW RATE	m ³ /h	1000 (800-1000)	1500 (1100-2000)	3000 (2300-3500)	4000 (3600-4500)
	CFM	590	880	1800	2350
NOISE LEVEL	dB(A)	42	42	47	49
STATIC PRESSURE	Pa	450	450	450	450
POWER SUPPLY	V	1x200-230 V 50/60 Hz	1x200-230 V 50/60 Hz	1x200-230 V 50/60 Hz	1x200-230 V 50/60 Hz
FAN	TYPE	PLUG FAN EC	PLUG FAN EC	PLUG FAN EC	PLUG FAN EC
	kW	0.9	1.15	1.44	2.03

* Noise levels calculated at 1 m from the free discharge and suction unit for the indoor unit.

Data subject to modifications due to adjustments to the designs without prior notice.

The nominal cooling capacities under conditions: Return 27 CBS/19 CBH, outdoor temperature 35 CBS. The nominal heating capacities under conditions: Return 20°CBS, outdoor temperature 7°CBS/6°CBH. Range in indoor operating conditions: Cooling 17°CBS to 32°CBS heat 10 CBS to 28 CBS. Range in outdoor operating conditions: Cooling 10°C to 45°C heat -7°C to 24°C.

Configuration

GC BS B

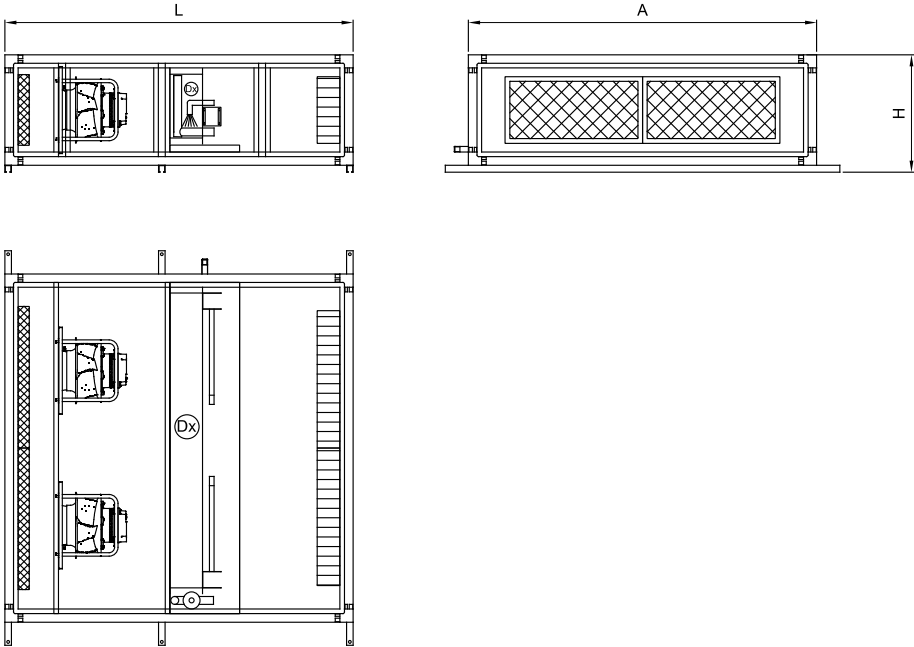

GC BS V

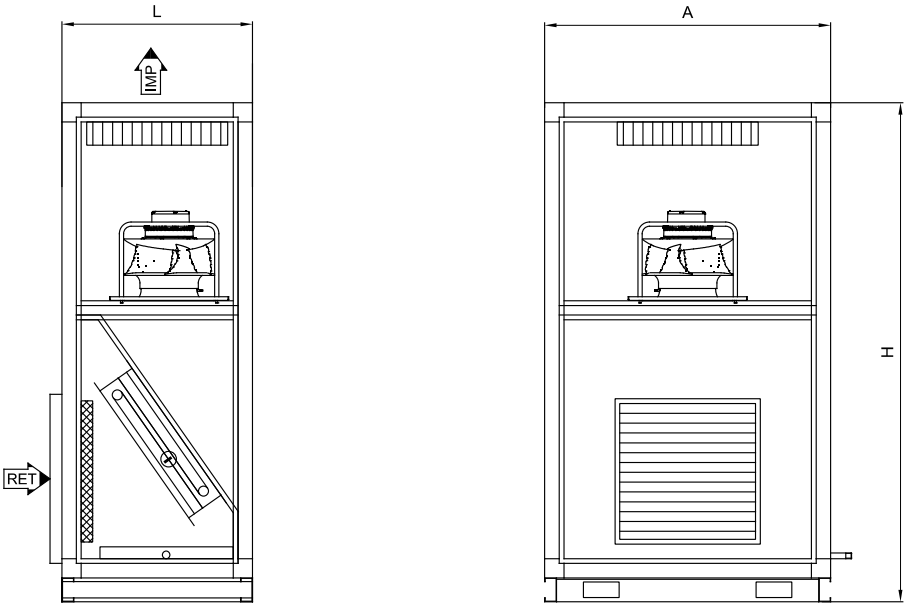

Vertical UP-FLOW air conditioners GC BS U series

Bidirectional vertical air conditioners with a hygienic construction for UP-FLOW operation and especially designed to be easily transported using lifts, hoists or through 80 cm doors, ideal for use during building renovations. It is possible to configure these units with lower or upper supply and return.



GC BS U
series

Technical characteristics

Model		GC 1.5 BS U 2.0 14 18 DX/Ho	GC 3.0 BS U 3.0 20 18 DX/Ho	GC 4.5 BS U 4.0 26 18 DX/Ho	GC 4.5 BS U 4.5 30 18 DX/Ho
COOLING CAPACITY	kW	13.17	19.74	26.53	29.91
	TR	3.7	5.6	7.5	8.5
HEATING CAPACITY	kW	12.31	18.46	24.61	27.69
	KCAL	10587	15876	21165	23813
FLOW RATE	m ³ /h	2000	3000	4000	4500
	CFM	1176	1765	2353	2647
CONSUMPTION	W	763	1217	1384	1572
	A	1.29	2.1	2.3	2.7
NOISE LEVEL	dB(A)	42	46	43	46
STATIC PRESSURE	Pa	400*	400*	400*	400*
POWER SUPPLY	V	3x380-415 V 50/60 Hz	3x380-415 V 50/60 Hz	3x380-415 V 50/60 Hz	3x380-415 V 50/60 Hz
FAN	TYPE	PLUG FAN EC	PLUG FAN EC	PLUG FAN EC	PLUG FAN EC

* Noise levels calculated at 1 m from the free discharge and suction unit for the indoor unit.

* Pressure available with a single coil and G4 (ISO COARSE 60%) + F8 filtering (ePM1 70%). *Considered air supply temperature 12.5°C and 38°C. The nominal cooling capacities under conditions: Return 27 CBS/19 CBH, outdoor temperature 35 CBS. The nominal heating capacities under conditions: Return 20°CBS, outdoor temperature 7°CBS/6°CBH. Data subject to modifications due to adjustments to the designs without prior notice.

Configuration

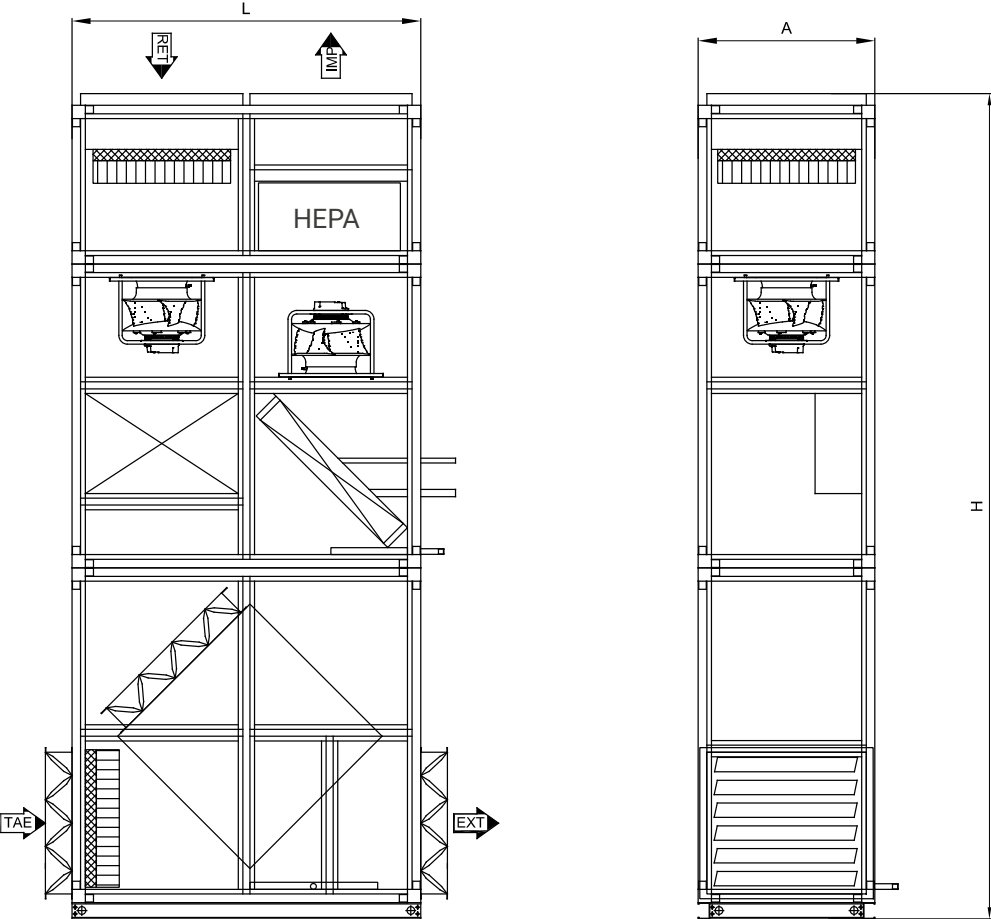

Air treatment units with low noise levels

Small air conditioners with low noise levels

Air conditioners with silent operation

GC BNS
series



GC BNS series

Air conditioners with low noise levels GC BNS series

Air conditioners specially designed to offer the highest performance with silent operation. To be located in spaces with the most demanding acoustic criteria.

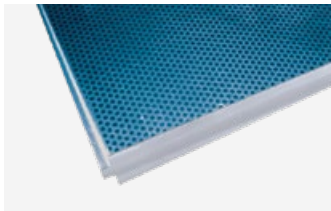

Double-sided panels and perforated plate with 25 mm interior thermal and acoustic insulation

The quality of DECACLIMA's GC units is guaranteed by the **Eurovent certification**



Main characteristics

- Hygienic construction in accordance with UNE/EN 13053, DIN 1946-4 and ASHRAE 170
- G4 (ISO COARSE 60%) and F9 filtering (ePM1 80%)
- Dirty filter pressure switch
- Plug Fan EC fans with flow regulator or constant pressure
- Extruded aluminium profile with thermal bridge break
- AISI 304 stainless steel condensates tray
- Double-sided and perforated plate panels with 25 mm interior thermal and acoustic insulation
- Perforated plate inside
- Low noise level

Standard finishes

- Galvanised steel interior with perforated plate
- Lacquered sheet exterior
- Modular aluminium structure
- Sanitation baseboard

Options

- High filtering efficiency
- Rock wool panel silencers

Technical characteristics

Model			GC 0.7 BS BNS 0.8 5 1 HO	GC 1.5 BS BNS 1.2 8 1 HO	GC 1.5 BS BNS 1.5 9 1 HO	GC 3.0 BS BNS 2.0 12 1 HO	
COOLING CAPACITY ¹		kW	5.0	7.1	9.1	12.0	
NOMINAL FLOW RATE		m ³ /h	800	1200	1500	2000	
STATIC PRESSURE AVAILABLE		Pa	150	150	150	200	
POWER SUPPLY		V	1x200-230 V 50/60 Hz	1x200-230 V 50/60 Hz	1x200-230 V 50/60 Hz	1x200-230 V 50/60 Hz	
FAN		Type	PLUG FAN EC	PLUG FAN EC	PLUG FAN EC	PLUG FAN EC	
		kW	0.16	0.21	0.28	0.38	
COOLING COIL		WATER SIDE LOAD LOSS	kPa	60.0	51.2	49.2	23.6
		WATER FLOW RATE IN COIL	l/h	858	1216	1555	2051
OPTIONS	HEATING COIL 45/40°C	HEATING CAPACITY	kW	5.6	8.3	10.4	13.8
		WATER SIDE LOAD LOSS	kPa	63.9	58.6	53.8	42.9
		WATER FLOW RATE IN COIL	l/h	971	1440	1800	2984
	HEATING COIL 75/65°C	HEATING CAPACITY	kW	8.2	12.2	15.4	20.6
		WATER SIDE LOAD LOSS	kPa	20.5	16.5	32.9	38.8
		WATER FLOW RATE IN COIL	l/h	724	1065	1352	1816
NOISE LEVEL ²		dB(A)	34	37	41	43	

Model			GC 3.0 BS BNS 2.5 15 1 HO	GC 3.0 BS BNS 3.0 18 1 HO	GC 4.5 BS BNS 4.0 24 1 HO	
COOLING CAPACITY *		kW	14.9	18.4	24.1	
NOMINAL FLOW RATE		m ³ /h	2500	3000	4000	
STATIC PRESSURE AVAILABLE		Pa	200	300	300	
POWER SUPPLY		V	1x200-230 V 50/60 Hz	3x380-415 V 50/60 Hz	3x380-415 V 50/60 Hz	
FAN		Type	PLUG FAN EC	PLUG FAN EC	PLUG FAN EC	
		kW	0.66	0.66	1.04	
COOLING COIL		WATER SIDE LOAD LOSS	kPa	40.4	44.7	59.0
		WATER FLOW RATE IN COIL	l/h	2550	3114	4130
OPTIONS	HEATING COIL 45/40°C	HEATING CAPACITY	kW	17.2	20.7	27.6
		WATER SIDE LOAD LOSS	kPa	22.6	48.5	60.2
		WATER FLOW RATE IN COIL	l/h	2675	3572	4792
	HEATING COIL 75/65°C	HEATING CAPACITY	kW	25.4	30.8	40.6
		WATER SIDE LOAD LOSS	kPa	32.4	34.0	39.0
		WATER FLOW RATE IN COIL	l/h	2239	2710	3580
NOISE LEVEL ²		dB(A)	47	44	49	

1. Coil water temperature 7/12°C.

2. Inlet sound levels + radiated by the casing calculated at 2 m from the unit.

The nominal cooling capacities under conditions: Return 27°CBS/19°CBH, outdoor temperature 35°CBS. The nominal heating capacities under conditions: Return 20°CBS, outdoor temperature 7°CBS/6°CBH. Range in indoor operating conditions: Cooling 17°CBS to 32°CBS Heating 10°CBS to 28°CBS. Range in outdoor operating conditions: Cooling 10°C to 45°C Heating -7°C to 24°C. Data subject to modifications due to adjustments to the designs without prior notice.

Dimensions mm

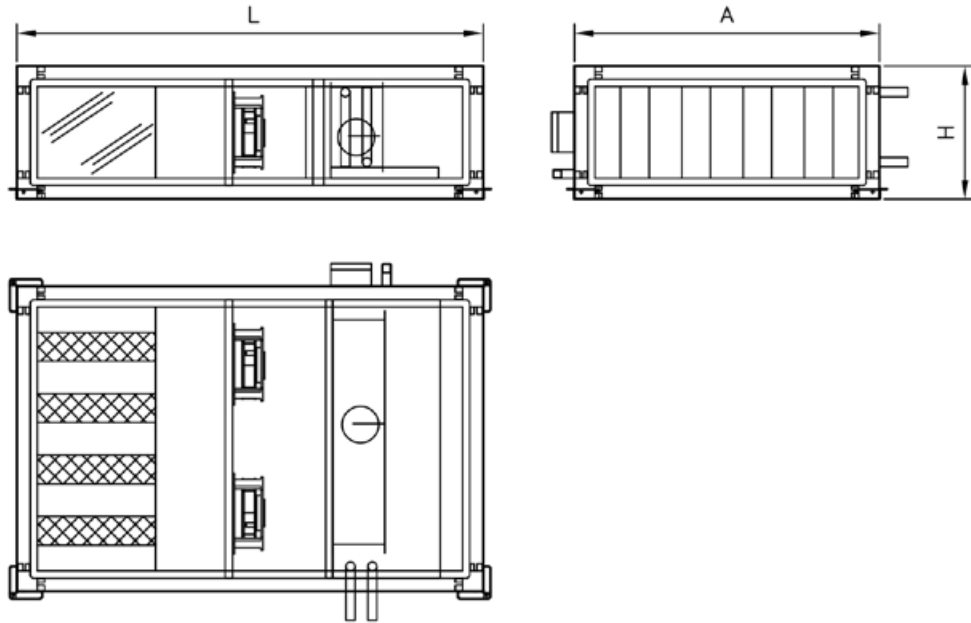

Model		GC 0.7 BS BNS 0.8 5 1 HO	GC 1.5 BS BNS 1.2 8 1 HO	GC 1.5 BS BNS 1.5 9 1 HO	GC 3.0 BS BNS 2.0 12 1 HO	GC 3.0 BS BNS 2.5 15 1 HO	GC 3.0 BS BNS 3.0 18 1 HO	GC 4.5 BS BNS 4.0 24 1 HO
WIDTH (A)	mm	800	850	850	950	1100	1100	1300
HEIGHT (H)	mm	340	370	430	474	474	554	580
LENGTH (L)	mm	1300	1300	1300	1420	1420	1600	1600
WEIGHT	kg	45	75	90	110	130	142	152

Dehumidifiers

Horizontal dehumidifier units

Dehumidifiers with heat pump
and Free Cooling recovery stage

GC DH
series



GC DH series

Dehumidifiers are units with a heat pump and exterior air heat recovery stage via Free Cooling GC DH series

The water vapour generated due to natural evaporation in any application where there is a high level of humidity causes damage to the construction materials and furniture in the environment and adverse effects for those occupying the area.



The quality of DECACLIMA's GC units is guaranteed by the **Eurovent certification**



Main characteristics

- Flow rates from 3,000 m³/h to 17,000 m³/h
- EC Plug Fan fans
- Extruded aluminium profile with thermal bridge break
- Rubber seal for water-tightness with the panels
- 50 mm thick sandwich-type panels, with a lacquered outer panel
- Evaporator with direct expansion heat exchanger with copper pipes and aluminium fins with special anti-corrosive finish
- Condenser with heat exchanger and cooling circuit using hermetic scroll compressors
- High-efficiency cross-flow heat recovery units
- Filtration stages for particle retention
- Built-in electrical panel
- Support frame adapted to the needs of the installation

Standard finishes

- Galvanised steel interior
- Lacquered sheet exterior
- Modular aluminium structure

Options

- UVc germicidal chamber
- Different filtration stages and characteristics
- Hatches module with heat recovery unit
- Different communication protocols

Operation

The DH dehumidifiers have been designed to manage the heating and dehumidification of the area, ensuring the necessary air renewal processes and ideal air quality for the comfort of people and the durability of construction materials and furniture.

The design of these units makes it a completely autonomous machine that includes all of the necessary characteristics to achieve and maintain

the preset comfort conditions. The DH dehumidifiers are capable of maintaining the desired temperature and humidity values in any installation, such as an indoor pool or sports centre, including a hot water coil to raise the air temperature and a cooling circuit that is used to dehumidify and heat the air.

The units include a cross-flow heat recovery unit to improve the machine's efficiency.

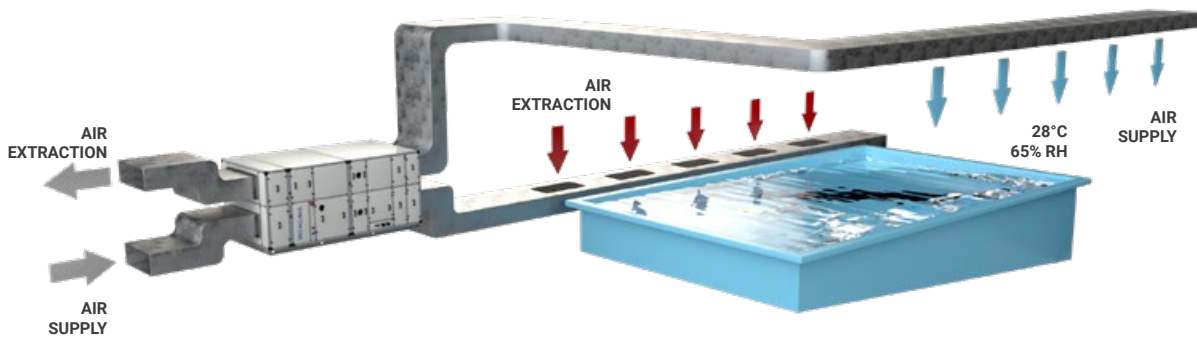

Constructive details

EXTERNAL PANELS

Sandwich-type panels with a steel surface finish with thicknesses from 25 mm to 50 mm, depending on the size. Designed to achieve optimum thermal insulation with thermal conductivity values of 0.024 w/m°C and also ensuring excellent acoustic insulation with high mechanical resistance.

HEATING STAGE

Coils with heat exchangers through the energy provided by the hot water generated by a boiler.

EXTERNAL STRUCTURE

Extruded aluminium profiles with nylon corners to ensure a perfect enclosure.



COOLING COILS

Coils with heat exchangers through the energy provided by the hot water generated by a boiler.

COOLING CIRCUIT

Cooling circuit made up of a hermetic or semi-hermetic compressor with internal protection and an evaporator and condenser coil in copper pipes and aluminium fins with anti-corrosive epoxy finish.

FILTERS

To improve indoor air conditions, filtration stages are required to capture particles and thus improve the quality of the air that people breathe in this environment.

CONTROL

Different controllers and communication protocols can be used depending on the needs of each installation.

Air treatment units for the naval sector

Specially designed for high corrosion environments

GC NLV V
Vertical air conditioners

GC NLV H
Horizontal air conditioners

GC NLV V
series

GC NLV H
series



GC NLV V series

**Stainless steel exterior finish, only as an option.*

Naval air conditioners designed with components for high corrosion environments GC NLV V series – GC NLV H series

In naval environments, the generation of water vapour due to natural evaporation in conditions of high humidity can cause damage to construction materials, affect furniture on board and have adverse effects for people.



**Stainless steel exterior finish, only as an option*

Fans used in naval and offshore applications are recognised for their excellent quality and performance by most ship manufacturers, as well as by civil defence companies around the world. These units can comply with the different requirements established by classification and certification bodies.



Main characteristics

- Flow rates from 1,000 m³/h to 80,000 m³/h
- Reinforced fans: AC plug fan, EC plug fan or transmission by belts and pulleys
- Hygienic construction in accordance with EN 13053
- High-quality components
- Wide variety of functions and options
- Extruded aluminium profile with thermal bridge break
- Rubber seal for air-tightness with the panels
- Casing with 50 mm sandwich-type panel, lacquered exterior and galvanised interior
- High-quality doors with locks for inspection and cleaning
- Support frames adapted to the needs of the installation
- Trays for collecting condensate, made of stainless steel, with drainage on both sides and breakwater elements to prevent overflows
- Copper pipe and aluminium fin coils, lacquered aluminium or copper
- Aluminium frames
- Aluminium regulation gates

Standard finishes

- Galvanised steel interior
- Lacquered sheet exterior
- Modular aluminium structure

Options

- Stainless steel exterior finish
- Stainless steel regulation gates
- Stainless steel frames
- Option of dividing the coil into modules
- Option of heat recovery coils
- Option of dividing the coil into modules
- Option of heat recovery coils

Bio-air conditioners

Air treatment units with evaporative cooling

GC BIO V
Vertical bio-air conditioners

GC BIO H
Horizontal bio-air conditioners

GC BIO V
series

GC BIO H
series



GC BIO V series

100% outdoor air bio-air conditioners with a high energy performance

GC BIO V series – GC BIO H series

Bio-air conditioners with double evaporative cooling system, with cellulose panels and an advanced energy recovery system.



The quality of DECACLIMA's GC units is guaranteed by the Eurovent certification



Main characteristics

- Flow rates from 1,000 m³/h to 80,000 m³/h
- EC Plug Fan
- Extruded aluminium profile with thermal bridge break
- Rotary or static heat-sensitive recovery unit
- Evaporative humidifiers in supply and return or outdoor air.
- Evaporative panels made of inorganic material to prevent coil proliferation
- Water recirculation pump
- Solenoid valve in water inlet and drain
- ON/OFF or proportional control panel with automatic tank emptying
- Self-cleaning system
- Conductivity sensor

Standard finishes

- Lacquered or stainless steel interior
- Acoustic panels
- Plug&Play built-in control

Options

- UVc germicidal chamber
- Water spray system using nozzles
- Different evaporative systems
- Windows for inspection and interior light

Technical characteristics

Model	Nominal flow rate m ³ /h	Model	Nominal flow rate m ³ /h	Model	Nominal flow rate m ³ /h
GC 1.5 BIO H	1500	GC 10.5 BIO H	10500	GC 30.0 BIO H	30000
GC 3.0 BIO H	3000	GC 12.0 BIO H	12000	GC 35.0 BIO H	35000
GC 4.5 BIO H	4500	GC 15.0 BIO H	15000	GC 40.0 BIO H	40000
GC 6.0 BIO H	6000	GC 18.0 BIO H	18000	GC 50.0 BIO H	50000
GC 7.5 BIO H	7500	GC 21.5 BIO H	21500	GC 60.0 BIO H	60000
GC 9.0 BIO H	9000	GC 24.0 BIO H	24000	GC 80.0 BIO H	80000

Configuration

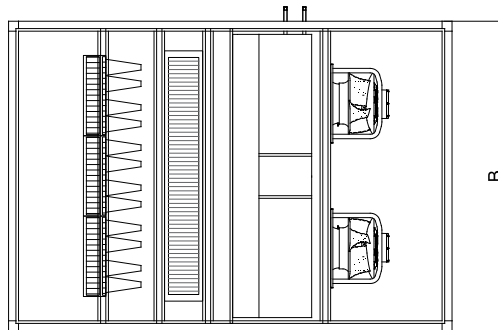
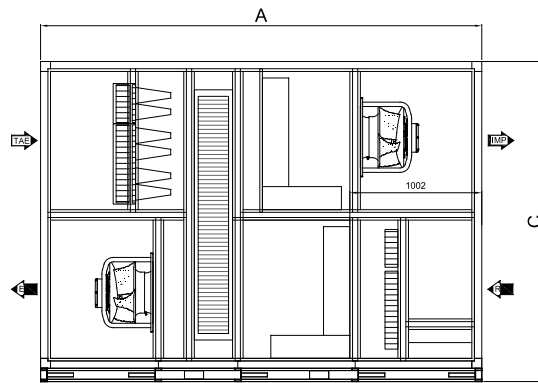

Quick select

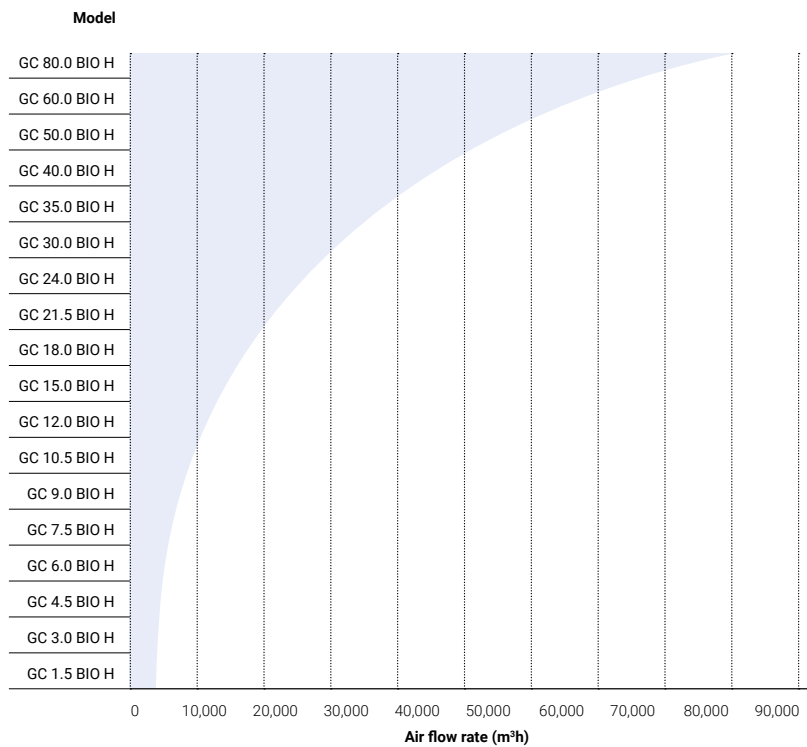

Heat recovery units

High efficiency units with rotary heat exchanger

GC RER H – GC RER V

Heat recovery units
with high efficiency rotary
heat exchanger

GC RER H
GC RER V
series



GC RER H
series

Air treatment units with heat recovery unit

GC RER H series – GC RER V series

GC RER series heat recovery units are primary air treatment units designed for use in high energy efficiency installations. They allow air treatment in terms of both thermal/hygrometric parameters and air quality, and can integrate humidification/dehumidification, air purification systems, etc. Ideal for combining with traditional water or VRF systems from almost all brands; in all cases they are Plug&Play units with controls that can be communicated in ModBus, BACnet or other protocols.

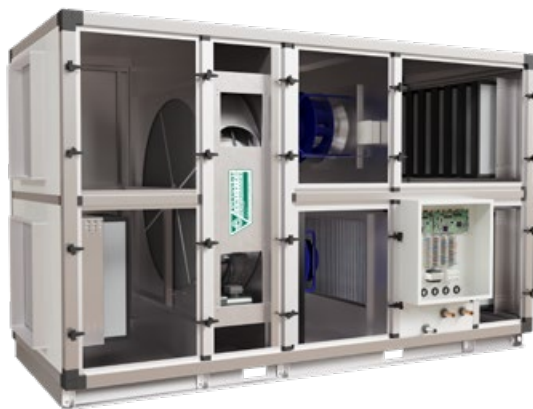

The quality of DECACLIMA's GC units is guaranteed by the **Eurovent certification**



Common characteristics

- High efficiency rotary heat recovery unit
- Plug Fan-type fans with EC technology motors
- Free Cooling function
- Built-in control with electrical power protections
- Extruded aluminium profile with thermal bridge break
- 50 mm thick sandwich-type panels, with a lacquered outer panel
- Ready for outdoor installation
- G4 series filtration (ISO COARSE 60%) + M6 (ePM10 70%) (rigid bags) TAE, F8 (ePM1 70%) supply and G4 (ISO COARSE 60%) + M6 (ePM10 70%) return.
- Dirty filter alarm on screen
- Semi-recessed IP65 electrical cabinet
- Control by supply temperature
- ModBus connectivity

Finish

- Galvanised steel interior
- Lacquered sheet exterior
- Modular aluminium structure

Options

- Coils for air treatment with two or four tubes
- Direct expansion coils
- Integration of AHU kits for interconnection with VRF installations
- Modules with UVC germicidal chamber
- Impulsion steam humidifier
- Water or electrical coils for preheating in cold areas
- Evaporative cooler
- Flow rate regulation by CO₂ concentrations
- Control of supply temperature/humidity and return humidity
- Filtering of other efficiencies

Characteristics based on size

	GC RER 3.0 H	GC RER 4.5 H	GC RER 6.0 H	GC RER 9.0 H	GC RER 13.5 H	GC RER 18.0 H	GC RER 20.0 H
SUPPLY FILTER (ODA)	G4 (ISO COARSE 60%) + M6 (ePM10 70%)	G4 (ISO COARSE 60%) + M6 (ePM10 70%)	G4 (ISO COARSE 60%) + M6 (ePM10 70%)	G4 (ISO COARSE 60%) + M6 (ePM10 70%)	G4 (ISO COARSE 60%) + M6 (ePM10 70%)	G4 (ISO COARSE 60%) + M6 (ePM10 70%)	G4 (ISO COARSE 60%) + M6 (ePM10 70%)
IMPULSION FILTER (SUP)	F8 (ePM1 70%)	F8 (ePM1 70%)	F8 (ePM1 70%)	F8 (ePM1 70%)	F8 (ePM1 70%)	F8 (ePM1 70%)	F8 (ePM1 70%)
EXTRACTION FILTER (ETA)	G4 (ISO COARSE 60%) + M6 (ePM10 70%)	G4 (ISO COARSE 60%) + M6 (ePM10 70%)	G4 (ISO COARSE 60%) + M6 (ePM10 70%)	G4 (ISO COARSE 60%) + M6 (ePM10 70%)	G4 (ISO COARSE 60%) + M6 (ePM10 70%)	G4 (ISO COARSE 60%) + M6 (ePM10 70%)	G4 (ISO COARSE 60%) + M6 (ePM10 70%)
PANEL THICKNESS	50 mm	50 mm	50 mm	50 mm	50 mm	50 mm	50 mm
PRESSURE SWITCH TO CONTROL BUILD-IN FILTER STATUS	YES	YES	YES	YES	YES	YES	YES
SAFETY AND MAINTENANCE SWITCH	YES	YES	YES	YES	YES	YES	YES
BUILT-IN CONTROL PANEL	YES	YES	YES	YES	YES	YES	YES

Technical characteristics

Model	SUPPLY			RETURN		
	Water flow rate	Absorbed power ¹	Static pressure available	Nominal flow rate	Absorbed power ¹	Static pressure available
	(m ³ /h)	(W)	(Pa)	(m ³ /h)	(W)	(Pa)
GC RER 3.0 H	3000	1435	300	3000	1022	300
GC RER 4.5 H	4500	2047	300	4500	1588	300
GC RER 6.0 H	6000	2877	300	6000	2238	300
GC RER 9.0 H	9000	4044	300	9000	3071	300
GC RER 13.5 H	13500	6052	300	13500	4703	300
GC RER 18.0 H	18000	8067	300	18000	6142	300
GC RER 20.0 H	20000	9228	300	20000	7117	300

Model	Voltage	Efficiency EN 13053	Class	Dry efficiency	Total capacity	Noise level ²	Weight
	(V)	(%)					
GC RER 3.0 H	3x400+N 50/60 Hz	75.4	H1	79.5	21.4	67	835
GC RER 4.5 H	3x400+N 50/60 Hz	76.1	H1	79.9	32.4	70	975
GC RER 6.0 H	3x400+N 50/60 Hz	74	H1	77.1	41	77	1050
GC RER 9.0 H	3x400+N 50/60 Hz	74	H1	76.9	61	73	1370
GC RER 13.5 H	3x400+N 50/60 Hz	76	H1	78.7	95	74	1750
GC RER 18.0 H	3x400+N 50/60 Hz	73	H1	76.2	97	76	1935
GC RER 20.0 H	3x400+N 50/60 Hz	74	H2	76.5	136	78	2290

1. Consumption given in nominal conditions.

2. The sound level values are pressures in dB(A) measured at a distance of 2 metres in a free field.

Dimensions mm

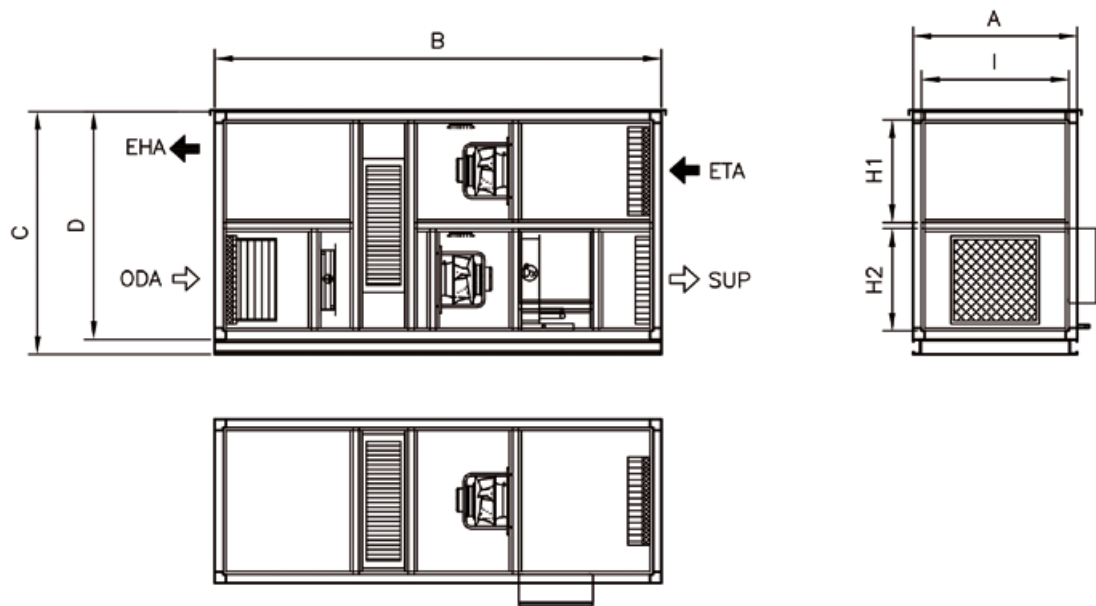

Model	A	B	C	D	H1	H2	I
GC RER 3.0 H	1100	3000	1630	1530	690	690	989
GC RER 4.5 H	1400	3000	1630	1530	390	690	1289
GC RER 6.0 H	1600	3150	1800	1700	810	739	1489
GC RER 9.0 H	2100	3350	2100	2000	924	924	1949
GC RER 13.5 H	2500	3450	2600	2500	1175	1175	2349
GC RER 18.0 H	2700	3500	2600	2500	1175	1175	2549
GC RER 20.0 H	3000	3500	2800	2700	1275	1275	2849

ODA: Fresh external air / SUP: Supply of air to premises / EHA: Exit of stale air / ETA: Air extraction from premises.
Data subject to modifications due to adjustments to the designs without prior notice.

Heating/cooling coils

Water coils for heating/cooling the air designed to be mounted on the unit itself.

HEATING COILS

Model	Flow rate (m ³ /h)	Boiler pre-heating 65°C / 50°C				Heat pump cooler preheating 45°C / 40°C			
		Water flow rate (l/h)	Water load loss (KPa)	Air load loss (Pa)	Power (kW)	Water flow rate (l/h)	Water load loss (KPa)	Air load loss (Pa)	Power (kW)
GC RER 3.0 H	3,000	1008	14.9	20	17.23	2997	19.9	33	17.23
GC RER 4.5 H	4,500	2272	12.7	38	25.85	4496	8.3	38	25.85
GC RER 6.0 H	6,000	3030	16.8	40	34.47	5994	9.9	40	34.47
GC RER 9.0 H	9,000	4545	8.2	42	51.70	8912	10.1	61	51.70
GC RER 13.5 H	13,500	6817	10.2	42	77.55	13488	16.4	61	77.55
GC RER 18.0 H	18,000	9090	16.5	42	103.40	17983	18.5	79	103.40
GC RER 20.0 H	20,000	10100	11.8	62	114.89	19982	17.7	99	114.89

Model	Flow rate (m ³ /h)	Boiler post-heating 65°C/50°C				Heat pump cooler preheating 45°C / 40°C			
		Water flow rate (l/h)	Water load loss (KPa)	Air load loss (Pa)	Power (kW)	Water flow rate (l/h)	Water load loss (KPa)	Air load loss (Pa)	Power (kW)
GC RER 3.0 H	3,000	495	13.1	15	8.47	1473	12.7	30.9	8.47
GC RER 4.5 H	4,500	734	8.6	17	12.56	2184	13.2	17	12.56
GC RER 6.0 H	6,000	1015	11.5	16	17.35	3123	9.5	26	17.35
GC RER 9.0 H	9,000	1593	23.9	17	27.24	5176	18.4	27	27.24
GC RER 13.5 H	13,500	2283	13.5	17	39.04	6789	8.2	36	39.04
GC RER 18.0 H	18,000	11584	14.2	66	66.06	11490	11.9	42	66.06
GC RER 20.0 H	20,500	12097	19.5	38	72.51	12612	13.7	43	72.51

COOLING COILS

Post-cooling cooler 7°C/12

Model	Flow rate (m ³ /h)	Water flow rate (l/h)	Water load loss (KPa)	Air load loss (Pa)	Power (kW)					
						Temp. Water inlet/outlet: 25°C 68% RH / 21°C 80% RH				
						GC RER 3.0 H	3,000	1651	15.9	48
GC RER 4.5 H	4,500	2398	14.5	56	13.98					
GC RER 6.0 H	6,000	3005	10.1	38	17.52					
GC RER 9.0 H	9,000	4652	18.2	40	27.12					
GC RER 13.5 H	13,500	7218	12.2	56	42.07					
GC RER 18.0 H	18,000	12692	16.7	63	73.98					
GC RER 20.0 H	20,500	14150	19.7	63	82.48					

Direct expansion coils

DX coils for interconnecting to VRF units

Temp. Air inlet/outlet: 26°C 66% RH / 22°C 78% RH

Model	Flow rate	Interior volume (l)	Temp. Evaporation	Air load loss (Pa)	Supply		Power (kW)
	(m³/h)		(°C)		Temperature (°C)	Humidity (%)	
GC RER 3.0 H	3000	3	8	48	22	78	7.65
GC RER 4.5 H	4500	4	8	51	22	78	11.49
GC RER 6.0 H	6000	3	8	28	22	78	14.00
GC RER 9.0 H	9000	8	8	49	22	77	23.77
GC RER 13.5 H	13500	6	8	30	22	77	33.52
GC RER 18.0 H	18000	15	8	52	22	77	67.16
GC RER 20.0 H	20000	17	8	49	20	83	76.21

DX coils for interconnecting to VRF units

Temp. Air inlet/outlet: 17°C 44% RH / 26°C 25% RH

Model	Flow rate	Interior volume (l)	Temp. Condensation	Air load loss (Pa)	Supply		Power (kW)
	(m³/h)		(°C)		Temperature (°C)	Humidity (%)	
GC RER 3.0 H	3000	3	45	31	26	25	14.09
GC RER 4.5 H	4500	4	45	38	26	25	14.09
GC RER 6.0 H	6000	4	45	21	23	28	13.69
GC RER 9.0 H	9000	7	45	33	25	26	27.24
GC RER 13.5 H	13500	6	45	16	25	26	30.72
GC RER 18.0 H	18000	13	45	34	26	23	64.28
GC RER 20.0 H	20000	17	45	32	26	23	70.75

Humidification section

Steam humidifiers using submerged electrodes or resistances are robust systems that allow steam production to be controlled, thus optimising air quality.

Humidifier

Model	Capacity	Voltage (V)	Consumption (kW)
	Kg/h		
GC RER 3.0 H	8	3x400+N	6.00
GC RER 4.5 H	10	3x400+N	8.20
GC RER 6.0 H	15	3x400+N	12.10
GC RER 9.0 H	25	3x400+N	18.75
GC RER 13.5 H	35	3x400+N	32.00
GC RER 18.0 H	50	3x400+N	39.80
GC RER 20.0 H	60	3x400+N	47.80

Calculated for an indoor condition of 20°C 50% RH, in winter.
Lance installed on the unit, humidifier requires installation on site.
Humidifier extends the unit approx. 600 mm in supply.

Air purifiers

With different filtration stages

Air purification units
with guaranteed effectiveness

PA
series



PA series



Units with guaranteed effectiveness

For the peace of mind of its clients, DECACLIMA offers a guarantee of quality and effectiveness thanks to the tests and certifications of its units tested in independent laboratories.



Air purification units with certified effectiveness

The air purification units have received the certificate of **anti-viral effectiveness** (100% in 10 minutes) and **against bacteria and fungi** (in 20 minutes), **without ozone emissions**.

The tests were carried out with mengovirus, a microorganism of the same family as SARS-CoV-2.



100% anti-viral effectiveness
in 10 minutes.



Air free of bacteria and fungi
in 20 minutes.



Without ozone emissions



Air purification units PA series

Units specifically designed to clean the air inside any type of space, primarily in high occupancy areas. Also suitable for health applications.



Main characteristics

- G4 (ISO COARSE 60%) and F7 filtering (ePM1 55%)
- EC variable speed fans
- 100% removable for cleaning
- Activated carbon filter
- Final filter F9 (ePM1 80%). 70% efficiency
- Panels with interior insulation

Standard finishes

- Galvanised steel interior/painted exterior
- Modular aluminium structure

Options

- UVc germicidal chamber
- HEPA filtering efficiency 99.995%
- Supply module with 1 grille
- Supply module with 3 grilles
- Wheel assembly
- Radiometer (indicates radiation, hours and percentage)

Configurations

- PAV vertical construction
- PAB horizontal construction

The range has two vertical configurations, ideal for direct mobile use in rooms. It can be connected to 240 V and can incorporate a supply module with outlets on 1 or 3 sides. The horizontal configuration is designed to be installed in false ceilings and connected by ducts to the premises where the air needs to be treated and allows outside air intake.

In both cases, these units are equipped with a filter package capable of removing at least 70% of particles larger than 0.4 μm (microns). Optionally, HEPA-type H14 filters can be installed with a minimum retention capacity of 99.995% of particles larger than 0.3 μm (microns). Both versions also incorporate an active carbon stage as standard, intended to remove bad odours produced by the use and occupation of the premises. Finally, it can feature a germicidal chamber constructed based on "C" range UV lamps in a spectrum of 253.7nm, a wave amplitude indicated to deactivate a wide variety of microorganisms. Cellular DNA and RNA absorb short wavelength UVc energy.

Technical characteristics

Model		PAV 1.5 17FG9 UV	PAV 3.0 17FG9 UV	PAV 4.5 17FG9 UV	PAV 6.0 17FG9 UV	PAB 1.5 17FG9 UV	PAB 3.0 17FG9 UV	PAB 4.5 17FG9 UV	PAB 6.0 17FG9 UV
FLOW RATE	m ³ /h	1500	3000	4500	6000	1500	3000	4500	6000
	CFM	883	1766	2649	3531	883	1766	2649	3531
AVAILABLE PRESSURE	PA ¹	300	300	300	300	300	300	300	300
POWER SUPPLY	V	I-200-230 V 50/60 Hz	I-200-230 V 50/60 Hz	I-200-230 V 50/60 Hz	I-200-230 V 50/60 Hz	I-200-230 V 50/60 Hz	I-200-230 V 50/60 Hz	I-200-230 V 50/60 Hz	I-200-230 V 50/60 Hz
NOISE LEVEL	dB ²	47	51	55	59	47	52	55	59
FAN	TYPE	PLUG FAN EC	PLUG FAN EC	PLUG FAN EC	PLUG FAN EC	PLUG FAN EC	PLUG FAN EC	PLUG FAN EC	PLUG FAN EC
	kW	0.78	1.35	2.7	2 x 2.7	0.78	1.56	2.7	2 x 2.7
UVc	Units	3	7	4	14	3	2	4	4
	W ³	21	49	70	98	21	51	70	102

¹ Available pressure given with G4 and F9 filter. / ² Noise levels calculated at 1 m from the unit. / ³ Effective power of UVc radiation.

Dimensions mm

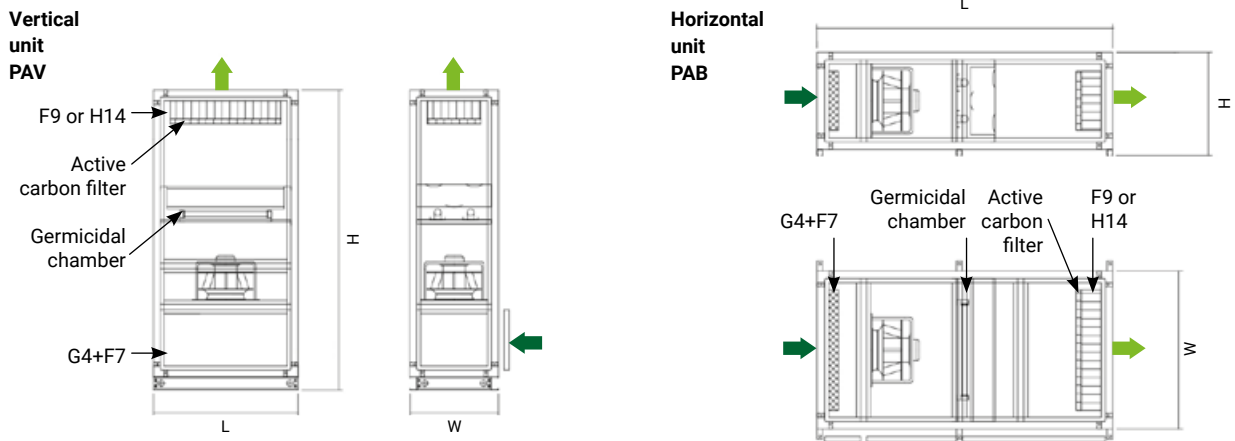

Model		PAV 1.5 17FG9 UV	PAV 3.0 17FG9 UV	PAV 4.5 17FG9 UV	PAV 6.0 17FG9 UV	PAB 1.5 17FG9 UV	PAB 3.0 17FG9 UV	PAB 4.5 17FG9 UV	PAB 6.0 17FG9 UV
LENGTH (L)	mm	774	774	1079	1504	1450	1450	1450	1450
WIDTH (W)	mm	474	779	779	779	774	1366	1079	1366
HEIGHT (H)	mm	1600	1600	1600	1600	474	474	779	779
SUPPLY MODULE	mm	324	490	490	490	-	-	-	-
BASE WEIGHT	kg	113	140	190	215	108	138	135	155
UVc MODULE	kg	5	5	6	14	5	6	9	10
SUPPLY MODULE	kg	25	33	42	55	-	-	-	-

*Data subject to change without prior warning

Optional air outlet modules



Germicidal modules for ducts

Units specifically designed for insertion in ducts and to clean the air inside any type of space, primarily in high occupancy areas. The range can be connected to 240 V, with easy installation in false ceilings.

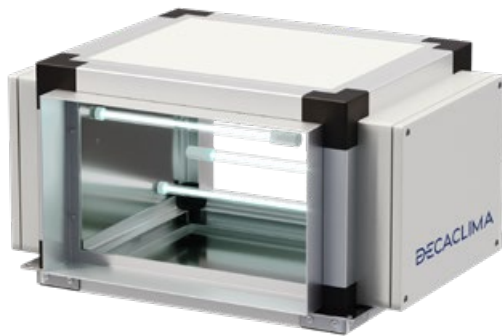

Unit constructed with "C" range UV lamps in a spectrum of 253.7 nm, wave amplitude indicated to deactivate a wide variety of microorganisms.

Cellular DNA and RNA absorb short wavelength UVc energy. UVGI technology has proven 99% effective in controlling microbial growth in the coil and drain pan area when installed correctly.

Main characteristics

- UVc lamps
- Panels with interior insulation
- Lugs for easy suspension
- Nozzles for easy installation in the duct
- Galvanised steel interior/painted exterior
- Modular aluminium structure

Options

- Radiometer (indicates radiation, hours and percentage)

Technical characteristics

Model		MGC 800 UV	MGC 1.200 UV	MGC 2.000 UV	MGC 3.000 UV	MGC 5.000 UV
FLOW RATE	m ³ /h	800	1200	2000	3000	5000
	CFM	471	706	1177	1766	2943
POWER SUPPLY	V	I-200-230 V 50/60 Hz	I-200-230 V 50/60 Hz	I-200-230 V 50/60 Hz	I-200-230 V 50/60 Hz	I-200-230 V 50/60 Hz
UVc	Units	2	4	6	10	12
	W*	14	28	42	70	84

* Effective power of UVc radiation

* Data subject to change without prior warning

Dimensions mm

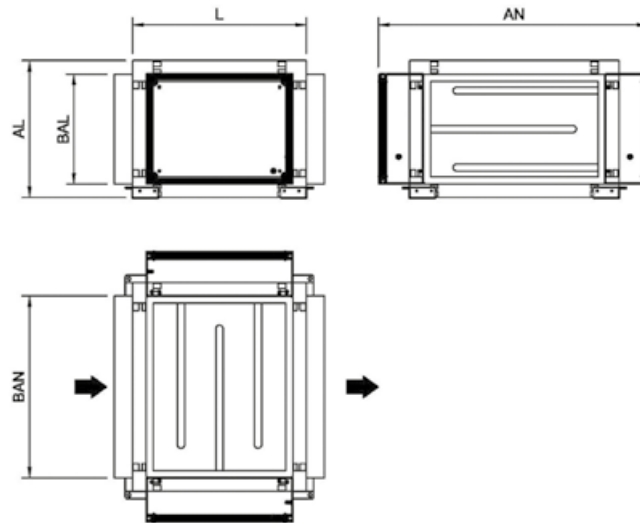

Model		MGC 800 UV	MGC 1.200 UV	MGC 2.000 UV	MGC 3.000 UV	MGC 5.000 UV
LENGTH (L)	mm	376	376	476	476	676
WIDTH (W)	mm	517	660	740	1040	1140
HEIGHT (H)	mm	276	276	376	376	476
NOZZLE (BAL)	mm	202	202	302	302	402
NOZZLE (BAN)	mm	400	500	500	800	900
WEIGHT	kg	15	21	29	37	50

*Data subject to change without prior warning

Radiometers

Equipment that allows you to monitor radiation levels (in $\mu\text{W}/\text{cm}^2$) and set the percentages to the desired level from 0 to 100%. Includes an operating hour counter for the unit and irradiation monitoring for units in critical applications. The radiometer ensures that the UVc lamps are working correctly.



ABSOLUTE MAXIMUM RATES

Parameter	Value		Comments
	Min.	Max.	
Supply voltage (V)	9	24	*Only 5 V (optional)
Supply current (A)		0.2	
Operating temperature ($^{\circ}\text{C}$)	-15	65	

CHARACTERISTICS AT 25°C

Parameter	Value		Comments
	Min.	Max.	
Detection range (nm)	220	280	10% peak
Detection power range ($\mu\text{W}/\text{cm}^2$)	1	2,500	

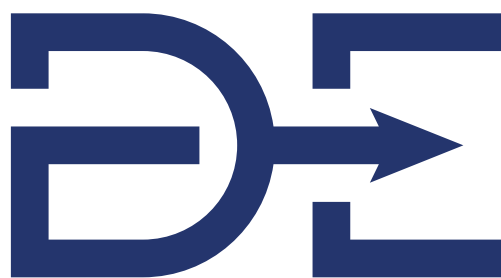

Innovation in air
treatment units

DECACLIMA COMFORT SOLUTIONS, S.L.

Avda. del Castell, 31
08570 Torelló (Barcelona)
Tel. +34 930 130 703
info@decaclima.com
www.decaclima.com

